

**FIELDERS**

OVERLAPPING LINE

# Fielders ShieldGuard™

**Class 4 Breathable Membrane**

**Installation Guide**

**WALLS**

Published 15 August 2024  
supersedes all previous versions.



## This Document

**Date Published:** 15 August 2024

**Summary of Updates:** • New publication

Ensure you have the most up-to-date version at [fielders.com.au](https://fielders.com.au)

# Contents

## Components

### Fielders ShieldGuard™ Class 4 Breathable Membrane

#### Tapes

Jointing Tape

Double Sided Tape

## Important Notes

### Steel Frame – Membrane Installation

1. Preparation of Steel Frame
2. Apply Double Sided Tape
3. Setting Out Membrane Installation
4. Securing and Aligning the Membrane
5. Securing Bottom Corners
6. Installing Subsequent Membrane Layers
7. Membrane Edge Sealing

### Steel Frame – Window Reveal Dressing

1. Window Reveal Dressing
2. Apply Double Sided Tape
3. Lining the Reveal
4. Sealing the Corners of the Reveal
5. Applying the Tape to Sill

### Steel Frame – Internal Corner Membrane Installation

1. Internal Corner Layout
2. Applying the Membrane to each Face
3. Cutting and Applying the Membrane
4. Sealing & Taping the Corner

### Timber Frame – Membrane Installation

1. Staples
2. Preparation of Timber Frame
3. Setting Out Membrane Installation
4. Initial Fixing of Membrane
5. Positioning and Fixing Bottom Edge
6. Fixing Bottom Corners
7. Securing the Membrane
8. Installing Successive Membrane Layers
9. Membrane Edge Sealing
10. Staple Head Sealing

### 4 Timber Frame – Window Reveal Dressing

- 4 1. Window Reveal Dressing 13
- 4 2. Folding the Reveals 13
- 4 3. Fixing the Reveals 13
- 4 4. Sealing the Corners of the Reveal 13
- 4 5. Applying Jointing Tape to Sill 14
- 4 6. Seal Over Staples 14

### 5 Timber Frame – Internal Corner Membrane Installation

- 5 1. Internal Corner Layout 15
- 5 2. Applying the Membrane to each Face 15
- 5 3. Cutting and Applying the Membrane 15
- 6 4. Sealing & Taping the Corner 15

### 6 Penetration Sealing

- 6 1. Cut for Penetrations 16
- 6 2. Push Pipe Through 16
- 6 3. Installing the EPDM Collar 16
- 6 4. Sealing the Collar Edge 16

### 7 Attachment Sealing

- 7 1. Sealing Other Attachments 17

### 9 Appendix: Australian Climate Zone Map

18

# Components

## Fielders ShieldGuard™ Class 4 Breathable Membrane



Roll Width (m)	Roll Length (m)	m <sup>2</sup> Per Roll	Pack Quantity	Unit Weight (kg)	Rolls Per Pallet
1.5	50	75	1	8.8	52

## Tapes

### Jointing Tape



Tape Width (mm)	Roll Length (m)	Pack Quantity	Rolls Per Box
60	25	1	20

### Double Sided Tape



Tape Width (mm)	Roll Length (m)	Pack Quantity	Rolls Per Box
25	100	1	12

## Important Notes

- ShieldGuard™ Breathable Membrane is a Class 4 building membrane or sarking that is designed for installation in commercial and residential wall and gable applications. It is suitable for use in most Australian Climate Zones\*. It is not suitable for applications in tropical Climate Zone 1.
- ShieldGuard™ must be installed in accordance with AS 4200.2.
- ShieldGuard™ must be installed with the printed surface facing outwards.
- Ensure a minimum overlap of 150mm between sections of the ShieldGuard™ membrane, or minimum 50mm and taped with Jointing Tape. As best practice to ensure optimum weatherproofing performance, a minimum 150mm overlap and Jointing tape can be used, as shown in the following installation guidelines.
- It is highly recommended that all exposed edges of the ShieldGuard™ membrane are properly sealed using the Jointing Tape for optimal weatherproofing performance.
- It is the responsibility of the specifier or project engineer to ensure that the ShieldGuard™ membrane and its details in this guide are appropriate for the intended application and building design.
- Refer to the ShieldGuard™ Technical Data Sheet for technical specifications and product details.
- ShieldGuard™ membrane is not designed to withstand prolonged direct exposure to the exterior elements. Upon installation of this product, the selected cladding must be installed within 3 months of installation.
- The installation guidelines herein are informational in nature only and may not be appropriate for use in all applications.
  - \* Refer to the Fielders Condensation Control document for best practice compliance to the NCC.

# Steel Frame - Membrane Installation

The guidelines below relate to installation using Double Sided Tape, which is suited to cladding directly fixed to the stud work. Mechanical fixings with a broad-headed washer at 300mm centres are to be used for cavity walls, as per AS 4200.2:2017.

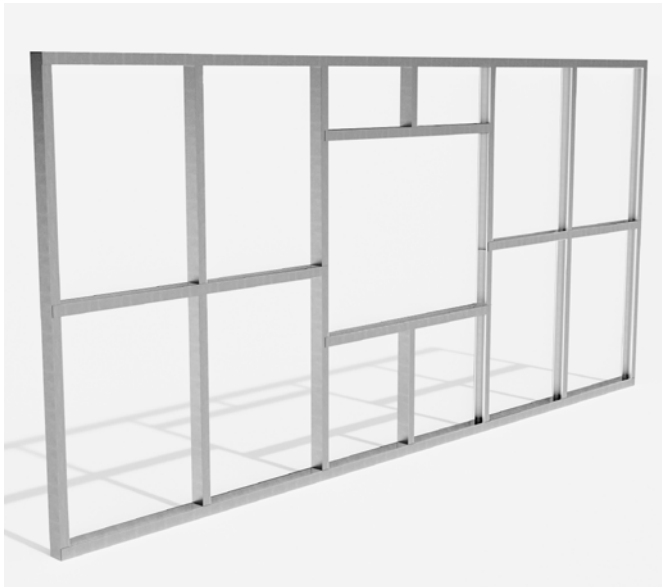

## 1 Preparation of Steel Frame

Before installing the membrane, carefully remove any sharp edges or burrs to prevent potential damage to the membrane during installation. Ensure the frame surface is clean and free from contaminants that could affect the adhesion of the Double Sided Tape.

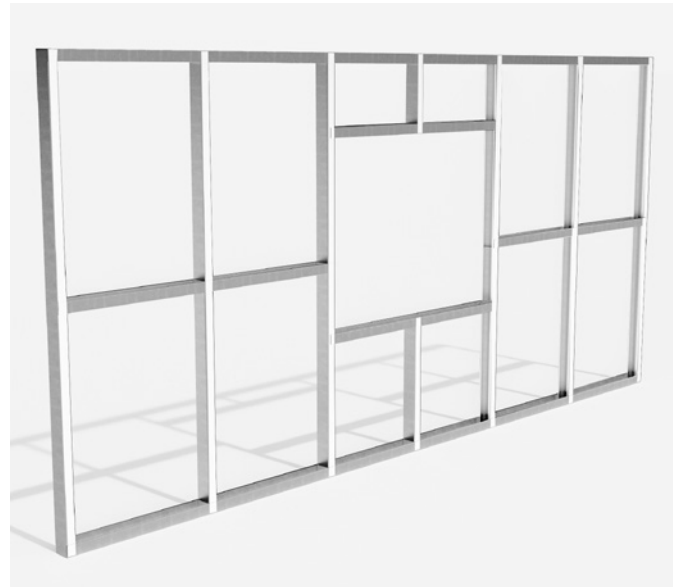

## 2 Apply Double Sided Tape

Apply the Double Sided Tape to all external faces of the metal framing. Press firmly onto the framing to ensure a good bond.

### Note:

For cavity walls, fix membrane at 300mm centres with suitable mechanical fixings, such as Galvanised hex head self-drilling screws with EPDM washer (12 gauge x 20 mm) and M8 large galvanised flat washers (8 x 32 x 1.8mm).

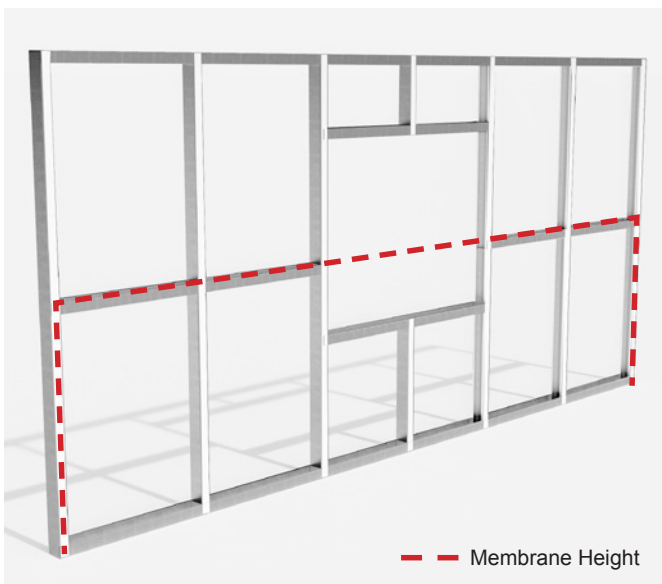

## 3 Setting Out Membrane Installation

From the bottom of the framing, measure and mark the exact height corresponding to the width of the membrane. This will indicate where the top of the first layer of the membrane should be installed.

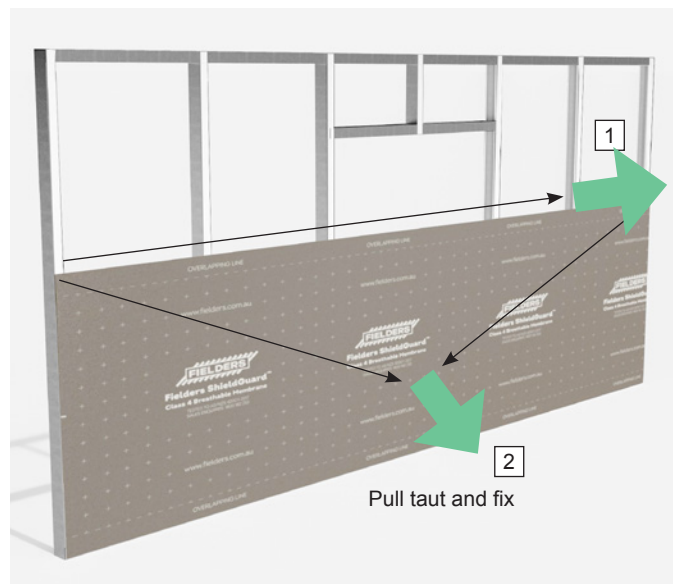

## 4 Securing and Aligning the Membrane

First, remove the release liner from the area designated for the initial membrane layer. Align with the marked line and pull taut and affix the top edge securely. Then, pull taut and fix the bottom centre edge.

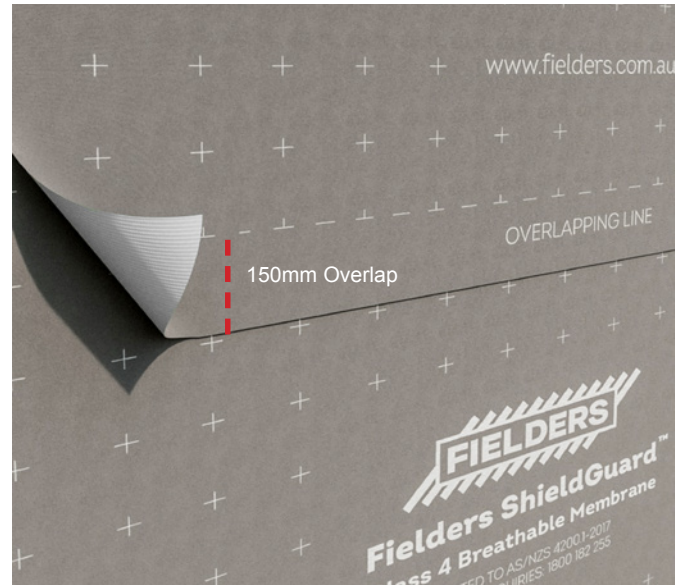
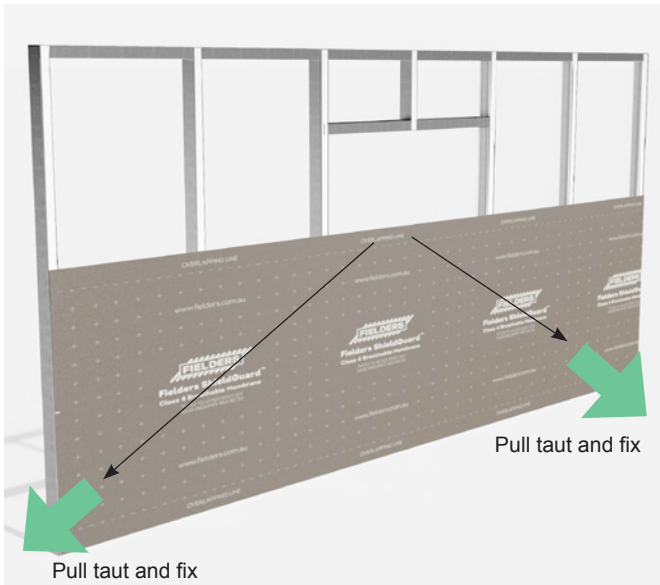

## 5 Securing Bottom Corners

Next, pull the membrane taut and adhere the bottom corners. Finally, press down firmly across the entire membrane section to ensure firm adhesion to the Double Sided Tape.

## 6 Installing Subsequent Membrane Layers

Continue installing the membrane layers above the first, using the same steps but in an upside down orientation. Ensure each new layer consistently overlaps the one beneath by at least 150mm. This overlap is critical for seamless coverage and optimal performance of the membrane system.

A minimum overlap of 50mm can be used in conjunction with taped joints.

All end laps must be fixed at a stud to form a continuous membrane.

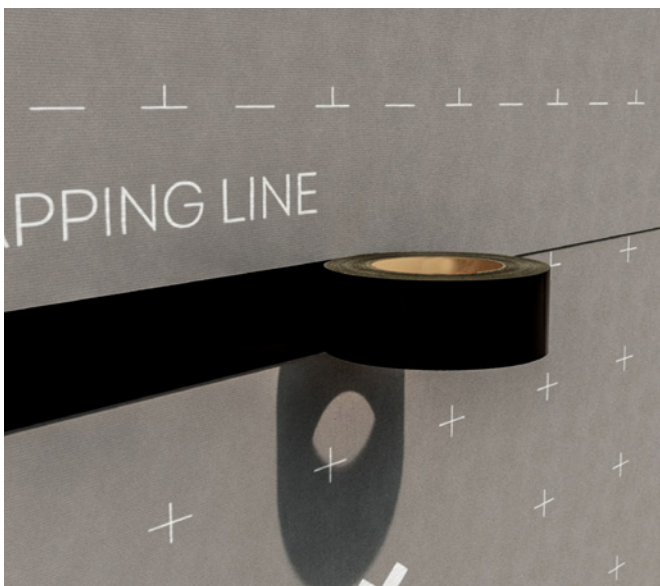

## 7 Membrane Edge Sealing

Once the membrane layers have been installed, seal all vertical and horizontal overlaps with Jointing Tape. Ensure that firm pressure is applied for secure and effective adhesion.

Overlaps of 50-150mm must be taped, as required by AS 4200.2:2017.

The Jointing Tape should be applied such that there is an equal amount of tape on either side of the joint (i.e. 30mm on each side).

# Steel Frame – Window Reveal Dressing

The following steps are guidelines only. Window reveal dressing should always consider the flashing detailing specific to the project. Refer to the Australian Glass & Window Association (AGWA) - *A Guide to Residential Installation* for additional information.

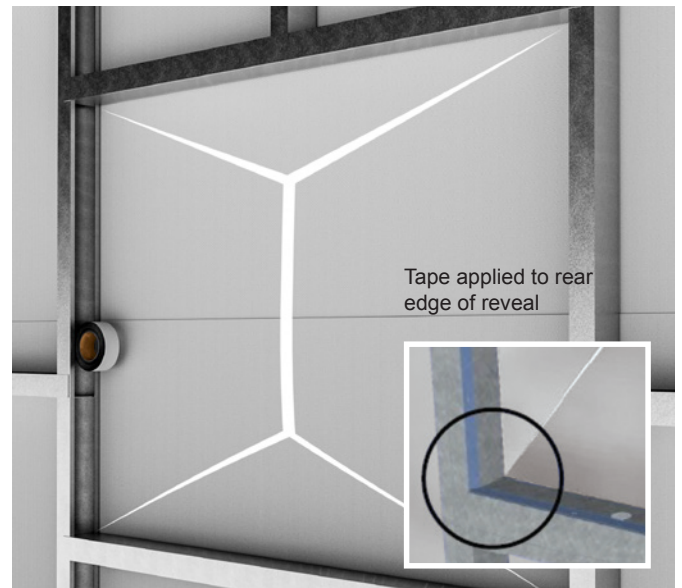
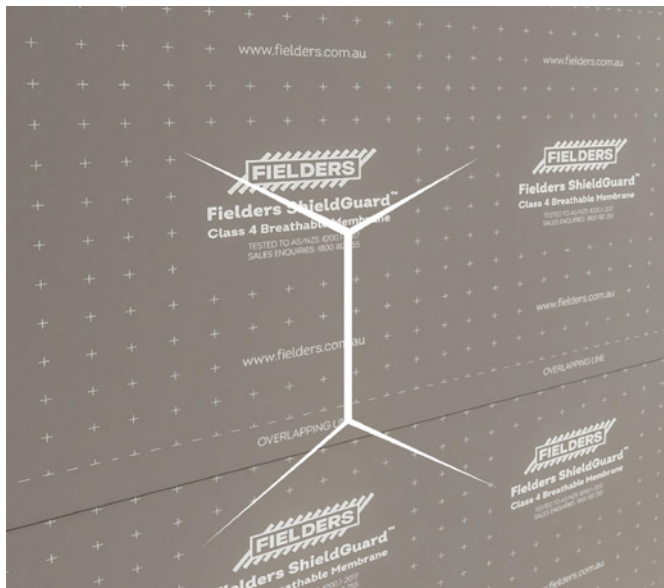

## 1 Window Reveal Dressing

Cut the membrane from the centre of the window area out towards each of the four corners, at 45° angles as shown. This will create four flaps that can then be folded neatly back into the window reveal.

## 2 Apply Double Sided Tape

Ensure surfaces are clean prior to tape application. Apply the Double Sided Tape along the rear edge of all four sides of the window reveal, then carefully remove the release liner.



## 3 Lining the Reveal

Fold the membrane flaps into the reveal, firmly pressing them onto the Double Sided Tape. Trim any excess membrane to align with the back edge of the metal framing for a neat finish.

## 4 Sealing the Corners of the Reveal

All corners of the window reveal must be thoroughly sealed. Start by applying the Jointing Tape directly over the membrane in each corner, extending at least 150mm up the jambs. Ensure that the tape is pressed firmly into place, covering the membrane completely in these areas.

Once the corners are secured, it is recommended to continue applying and stretching the tape around the front and back of the framing.

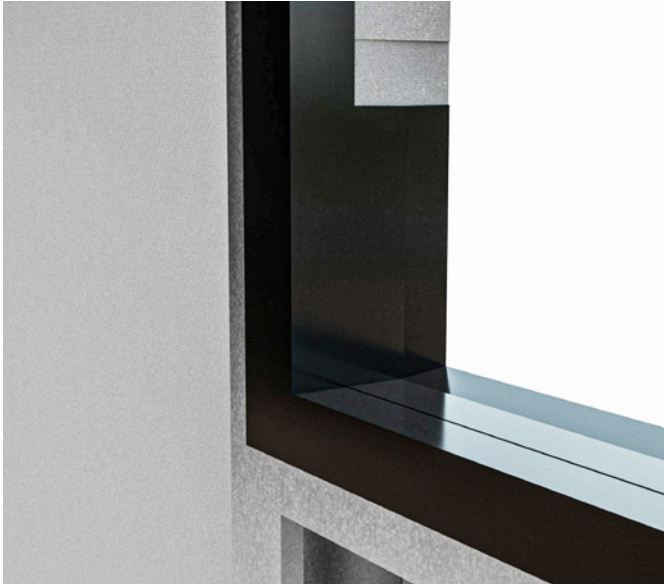

## 5 Applying the Tape to Sill (Best Practice)

To achieve optimal weatherproofing performance, repeat this process for the rear edge of the frame, then the right side followed by the left side. Finish off with the header.

Ensure that any exposed framing at the corners of the sill is sealed with tape.



# Steel Frame - Internal Corner Membrane Installation

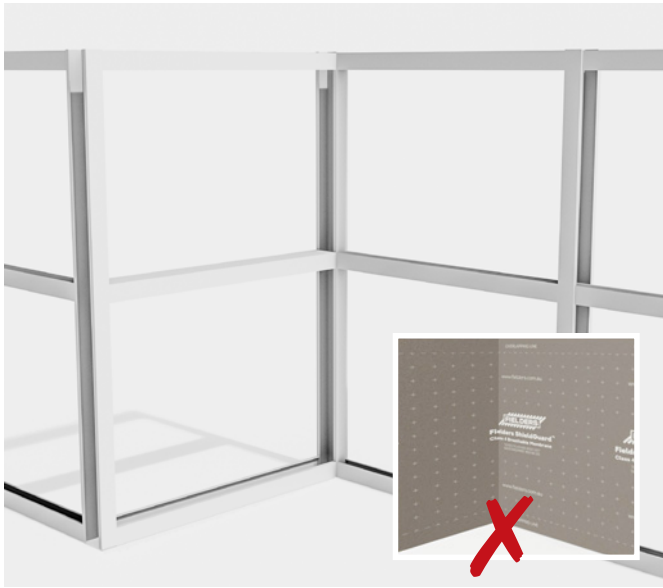

## 1 Internal Corner Layout

For internal corners, the membrane should be installed in two separate sections. This prevents curved corners and reduces the risk of accidental penetrations.



## 2 Applying the Membrane to each Face

First, align the membrane tightly into the corner and extend it outwards along the wall. Fix it back to the frame following the process described in previous sections.



## 3 Cutting and Applying the Membrane

Pull the second section of the membrane into the internal corner and trim it, ensuring a 150mm overlap. Fix the membrane securely back to the frame, following the previously described method.



## 4 Sealing & Taping the Corner

Press the membrane firmly into the corner to prevent any curvature or radius forming. Bond it temporarily to the first piece of membrane using the Double-Sided Tape. Finally, seal the exposed edge with the Jointing Tape.

### Note:

The Jointing Tape should never be applied directly over the corner. The tape seal between the two sections should always be positioned on a flat section of wall just away from the corner.

# Timber Frame - Membrane Installation

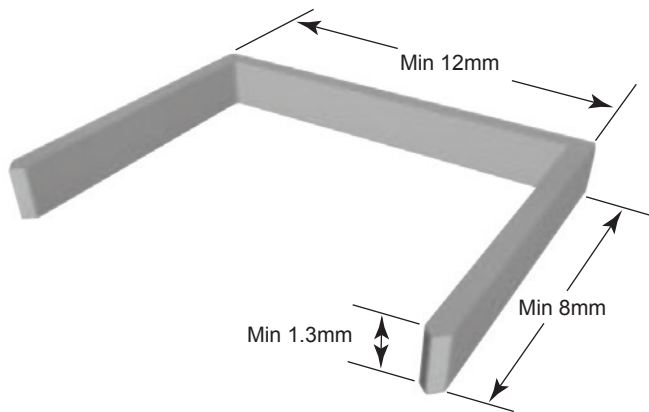

## 1 Staples

Staples must be zinc-coated or stainless-steel, with a minimum 12mm width and at least 1.3mm thick.

## 2 Preparation of Timber Frame

Carefully inspect the timber frame and address any sharp edges or protrusions that may tear or puncture the surface of the membrane.

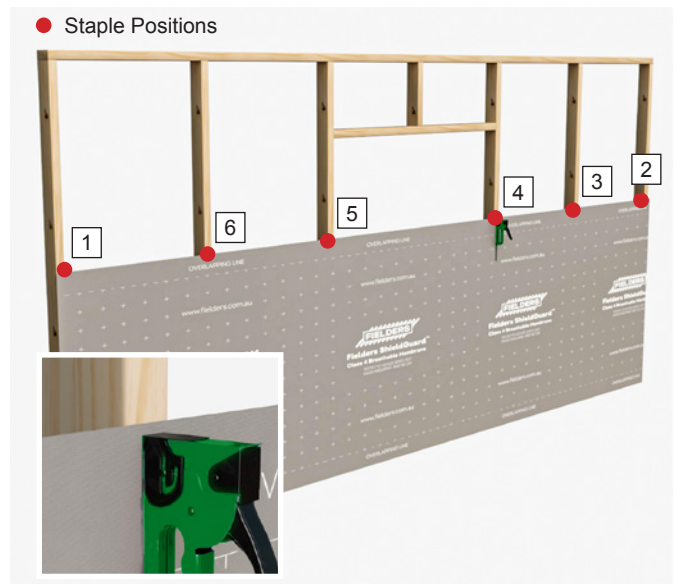
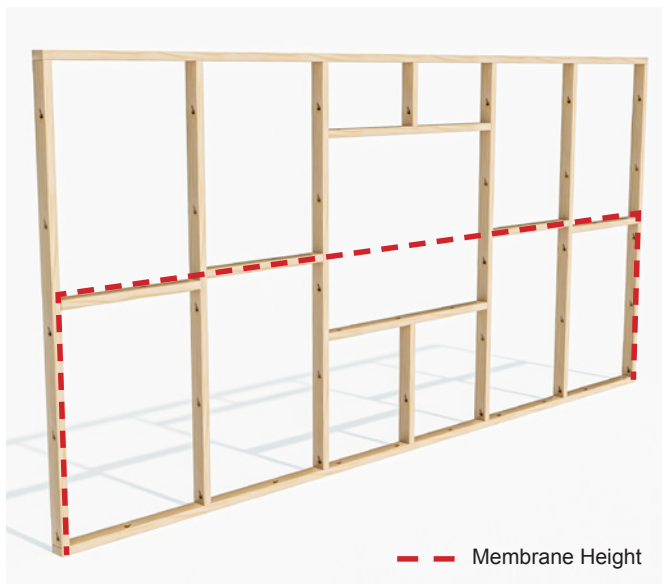

## 3 Setting Out Membrane Installation

Membrane installation starts from the bottom of the frame. Measure and mark out the exact height corresponding to the width of the membrane. This indicates where the top of the first layer of membrane should be positioned.

## 4 Initial Fixing of Membrane

Secure the top corner of the first layer of membrane with 4-6 staples, then roll out the membrane across the studs. If required, trim to length and pull the membrane taut before securing the opposite corner in the same way.

Continue to secure the top edge of the membrane at each stud, ensuring the staples are within 150mm from the edge.

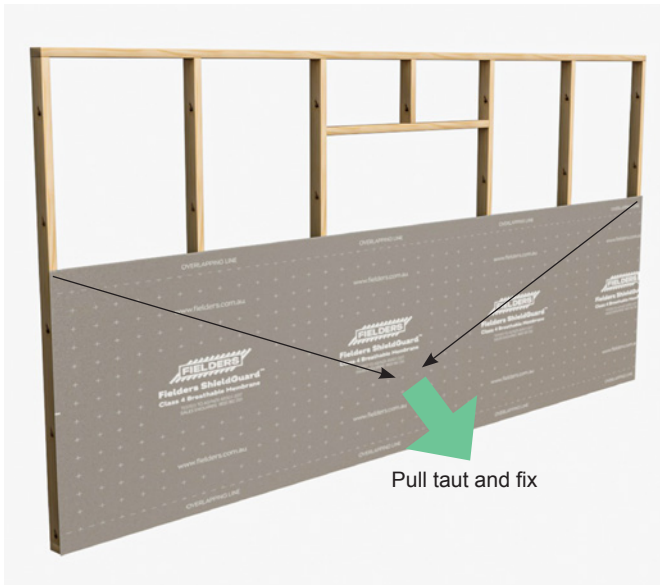

## 5 Positioning and Fixing Bottom Edge

Pull the membrane down from the centre until taut, and then secure with 2-4 staples at the bottom edge.

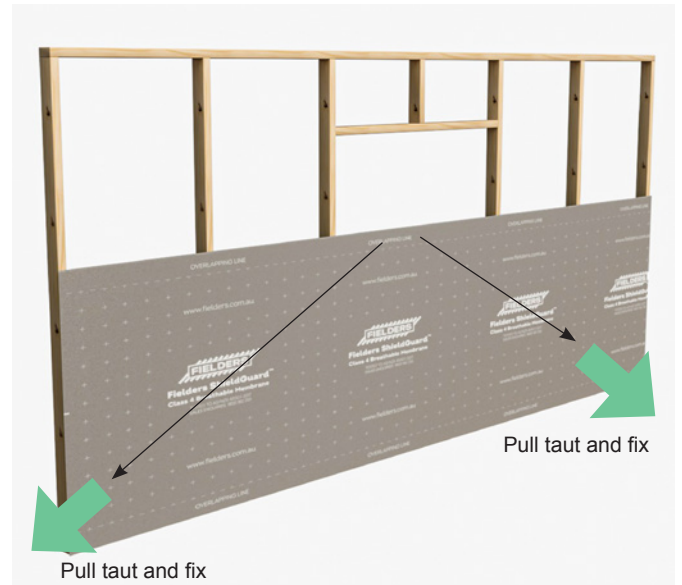

## 6 Fixing Bottom Corners

Pull the bottom corners taut and fix with 2-4 staples.



## 7 Securing the Membrane

Once the top and bottom edges of the membrane are secured, fix the membrane back at each vertical stud with staples at 150mm centres.

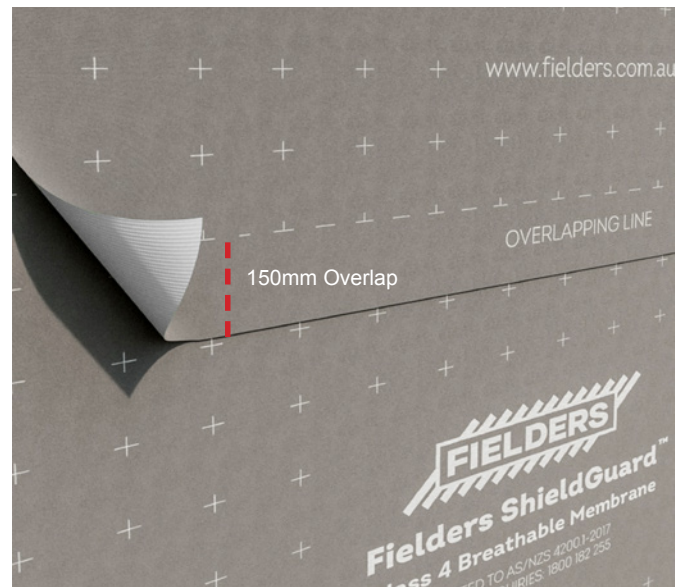

## 8 Installing Successive Membrane Layers

Continue installing the membrane layers above the first, using the same steps but in an upside-down orientation compared to the bottom layer.

Ensure that each new layer overlaps the one beneath by at least 150mm. This overlap is critical for seamless coverage and optimal performance of the membrane system. A minimum overlap of 50mm can be used in conjunction with taped joints.

All end laps must be fixed at a stud to form a continuous membrane.

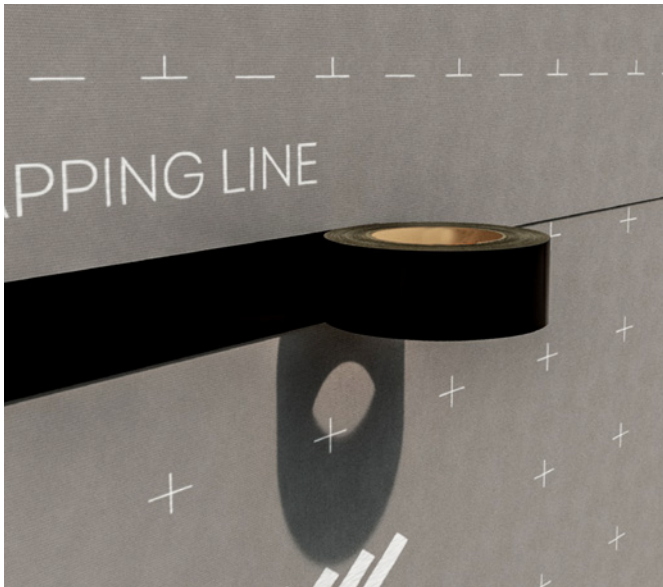

## 9 Membrane Edge Sealing

Once the membrane layers have been installed, seal all vertical and horizontal overlaps with Jointing Tape. Ensure that firm pressure is applied for secure and effective adhesion.

Overlaps of 50-150mm must be taped, as required by AS 4200.2:2017.

The Jointing Tape should be applied such that there is an equal amount of tape on either side of the joint (i.e. 30mm on each side).

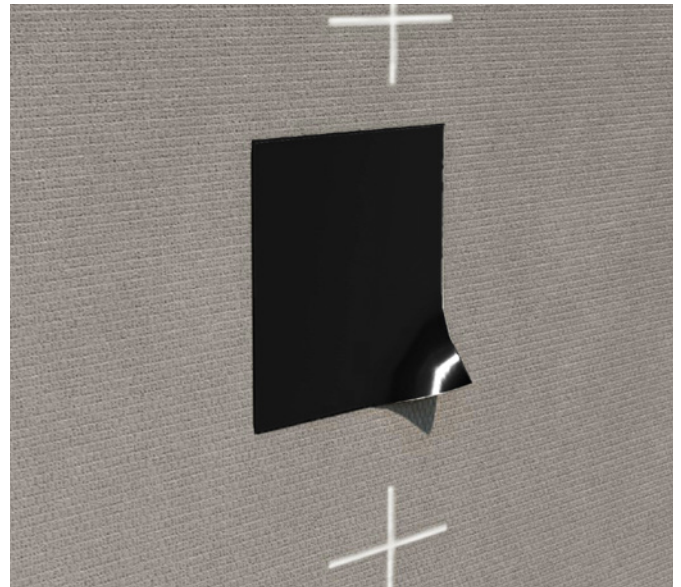

## 10 Staple Head Sealing (Best Practice)

For maximum level of weather resistance, cut squares of the Jointing Tape and place over each staple point.

# Timber Frame – Window Reveal Dressing

The following steps are guidelines only. Window reveal dressing should always consider the flashing detailing specific to the project. Refer to the Australian Glass & Window Association (AGWA) - *A Guide to Residential Installation* for additional information.

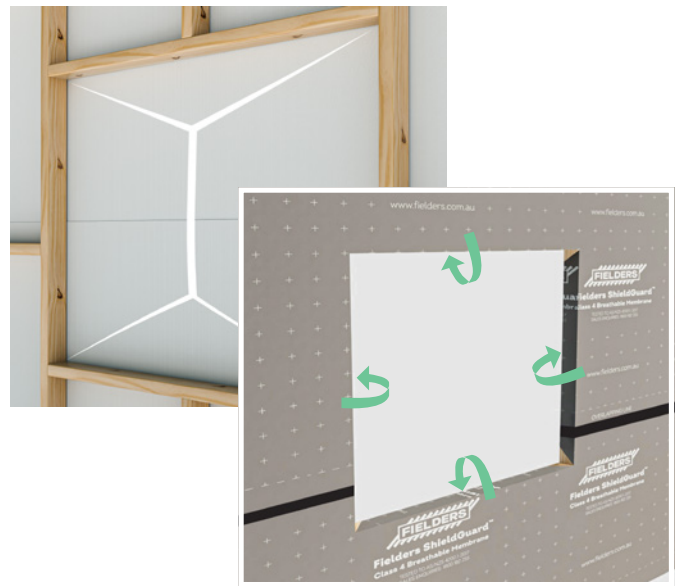
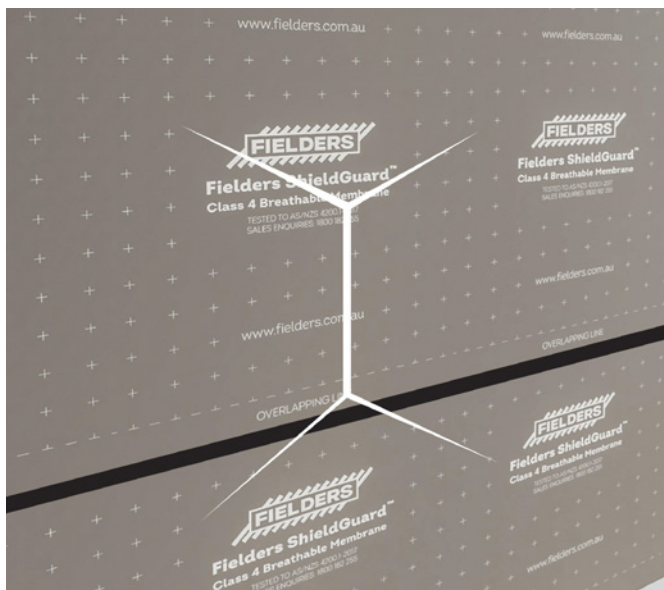

## 1 Window Reveal Dressing

Cut the membrane from the centre of the window area out towards each of the four corners, at 45° angles as shown. This will create four flaps that can then be folded neatly back into the window reveal.

## 2 Folding the Reveals

Ensure all four sides of the window reveal are clear and smooth, then fold the membrane flaps back into the reveal.

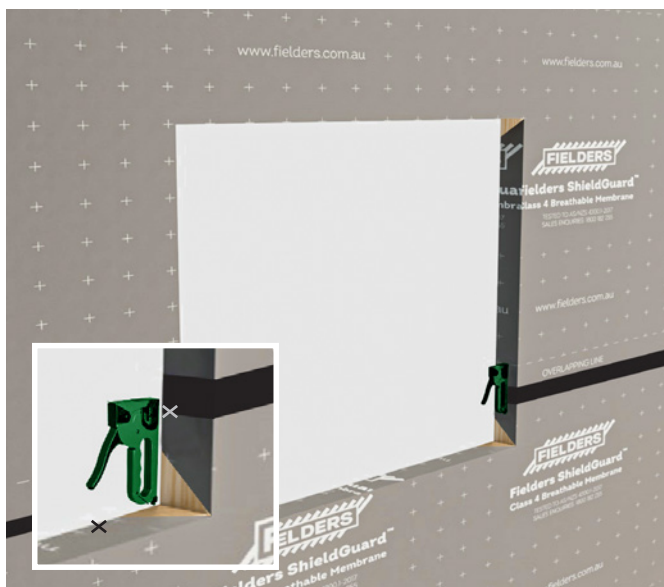

## 3 Fixing the Reveals

Keeping the membrane taut, secure the flaps using staples at the rear edge of the window reveal at 150mm centres. Trim back any excess membrane to align with the back edge of the timber frame for a neat finish.



## 4 Sealing the Corners of the Reveal

All corners of the window reveal must be thoroughly sealed. Start by applying the Jointing Tape directly over the membrane in each corner, extending at least 150mm up the jambs. Ensure that the tape is pressed firmly into place, covering the membrane completely in these areas. Once the corners are secured, it is recommended to continue applying and stretching the tape around the front and back of the framing.



## 5 Applying Jointing Tape to Sill (Best Practice)

To achieve optimal weatherproofing performance, repeat this process for the rear edge of the frame, followed by the right and left hand side. Finish off with the header.

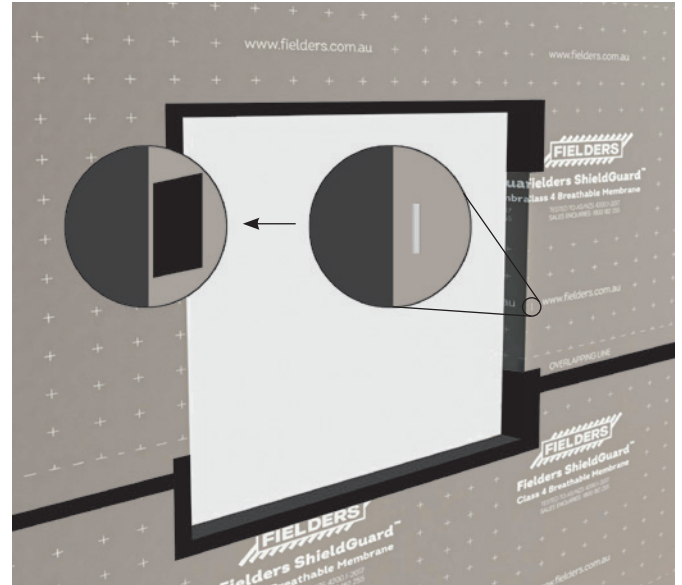

## 6 Seal Over Staples (Best Practice)

It is recommended that any remaining exposed staples around the window is covered with the Jointing Tape.

# Timber Frame – Internal Corner Membrane Installation



## 1 Internal Corner Layout

For internal corners, the membrane should be installed in two separate sections. This prevents curved corners and reduces the risk of accidental penetrations.



## 2 Applying the Membrane to each Face

First, align the membrane tightly into the corner and extend it outwards along the wall. Fix it back to the timber frame following the process described in previous sections.



## 3 Cutting and Applying the Membrane

Pull the second section of the membrane into the internal corner and trim it, ensuring a 150mm overlap. Fix the membrane securely back to the frame, following the previously described method with staples and then seal with patches of the Jointing Tape.



## 4 Sealing & Taping the Corner

Press the membrane firmly into the corner to prevent any curvature or radius forming. Bond it temporarily to the first piece of membrane using the Double-Sided Tape. Finally, seal the exposed edge with the Jointing Tape.

### Note:

The Jointing Tape should never be applied directly over the corner. The tape seal between the two sections should always be positioned on a flat section of wall just away from the corner.

# Penetration Sealing

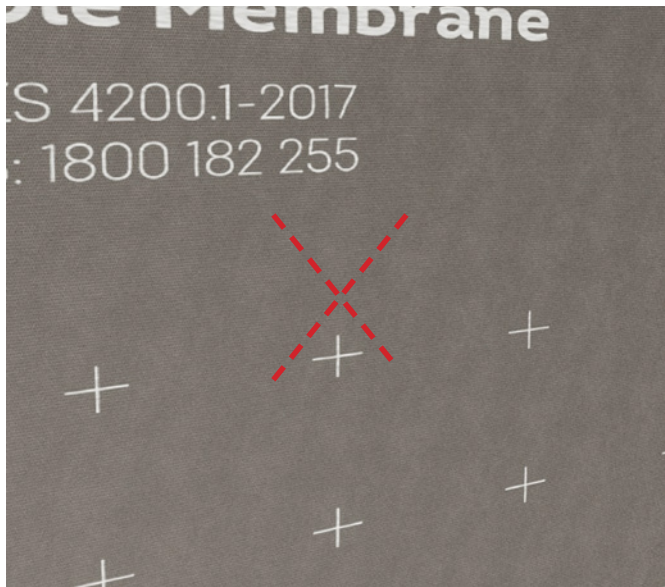

## 1 Cut for Penetrations

Make two 45-degree slits through the membrane, ensuring they are just large enough to fit the diameter of the pipe. Be careful not to extend the cuts too far.



## 2 Push Pipe Through

Push the pipe through the cuts in the membrane, and then trim away any excess material to aid the installation of the EPDM sealing collar (Steps 3-4).

If an EPDM collar is not used, the penetration can be sealed using Jointing tape.



## 3 Installing the EPDM Collar (Best Practice)

First, make sure the pipe is clean. Then, stretch the EPDM sealing collar over the pipe, ensuring a tight fit. Slide the sleeve up until it sits snugly against the face of the membrane.

**Note:**

Suitable EPDM collars such as Pro Clima ROFLEX and OBEX CORTEX 0920 Pre-formed Sleeves can be sourced separately and are not sold directly by Fielders.

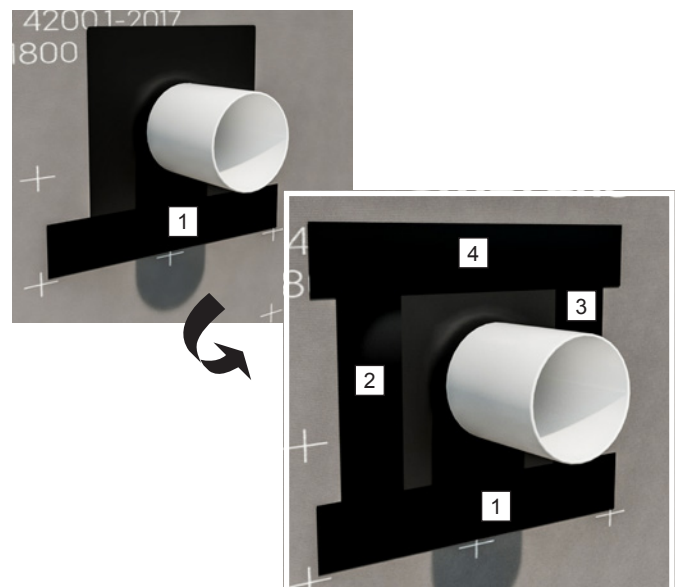

## 4 Sealing the Collar Edge (Best Practice)

First, apply the Jointing Tape along the bottom edge of the collar. Ensure that it forms a good bond onto both the collar and the membrane. Next, apply the Jointing Tape to the left and right edges of the collar. Finish by placing a final piece of tape across the top edge. It is critical that this sequence is followed to ensure a good seal.



# Attachment Sealing

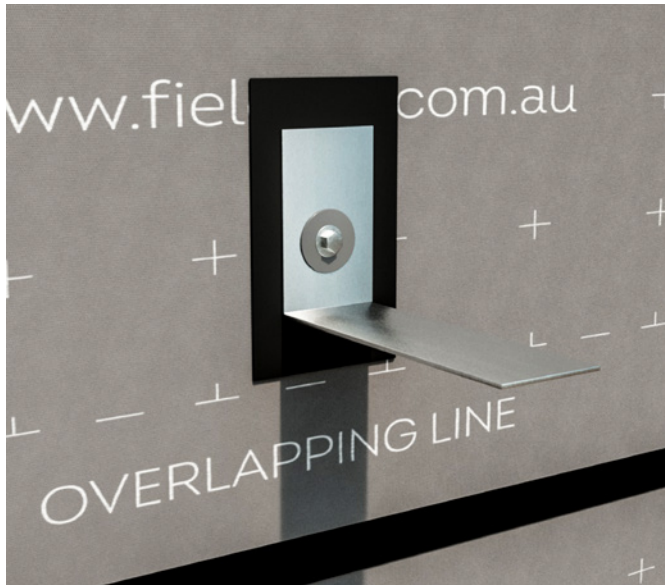

## 1 Sealing Other Attachments (Best Practice)

For attachments fixed to the studs through the Membrane, it is recommended that all edges be sealed with Jointing Tape for optimal weatherproofing performance.

# Appendix: Australian Climate Zone Map

A map of Australian climate zones can be found on the Australian Building Codes Board website.  
<https://www.abcb.gov.au/resources/climate-zone-map>.

The interactive map enables you to search for your climate zone based on address, suburb or postcode.

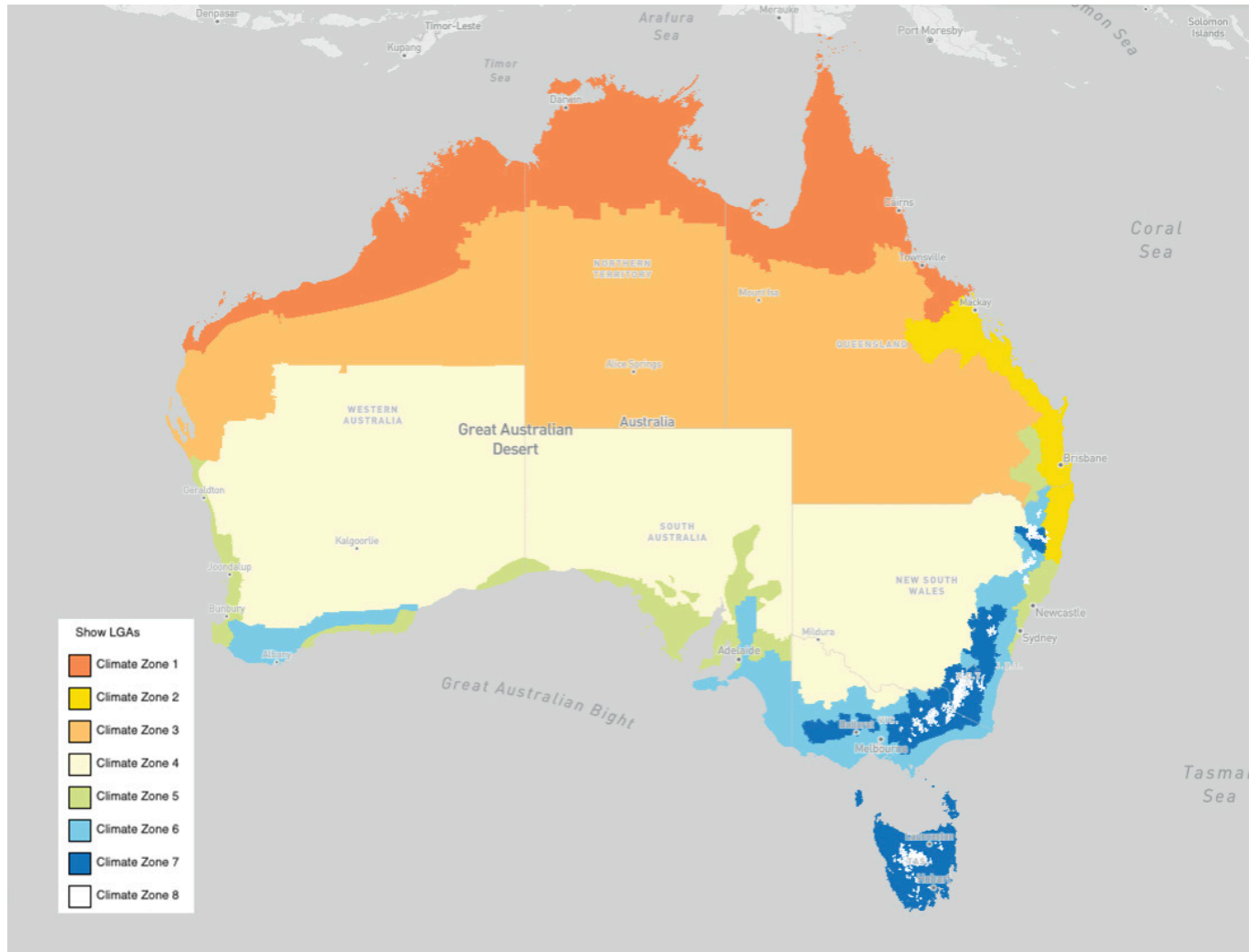

Climate zone map. Image source: Australian Building Codes Board. Accessed via <https://www.abcb.gov.au/resources/climate-zone-map>

This page left intentionally blank

## Product Descriptions

All descriptions, specifications, illustrations, drawings, data, dimensions, and weights contained in this publication and websites containing information from Fielders are approximations only. They are intended by Fielders to be a general description for information and identification purposes and do not create a sale by description. Fielders reserves the right at any time to:

- a) Supply goods with such minor modifications from its drawings and specifications as it sees fit, and
- b) Alter specifications shown in its publications and websites to reflect changes made after the date of publication.

## Disclaimer, Warranties and Limitations Of Liability

- Fielders ShieldGuard™ is warranted for a period of 12 years from delivery.
- This publication is intended to be an aid for all trades and professionals involved with specifying and installing Fielders® products and not be a substitute for professional judgement.
- Terms and conditions of sale are available at [fielders.com.au/legals/](https://fielders.com.au/legals/)
- Except to the extent to which liability may not lawfully be excluded or limited, BlueScope Steel Limited will not be under or incur any liability to you for any direct or indirect loss or damage (including, without limitation, consequential loss or damage such as loss of profit or anticipated profit, loss of use, damage to goodwill and loss due to delay) however caused (including, without limitation, breach of contract, negligence and/or breach of statute), which you may suffer or incur in connection with this publication.

## Australian Standards

Australian Standard	Title
AS 4200.1:2017	Pliable building membranes and underlays, Part 1: Materials
AS 4200.2:2017	Pliable building membranes and underlays, Part 2: Installation

For detailed product information, manuals and project case studies visit:

[fielders.com.au](https://fielders.com.au)

Fielders® and © product names are registered trademarks of BlueScope Steel Limited and ™ product names are trademarks of BlueScope Steel Limited.  
© 2024 BlueScope Steel Limited. ABN 16 000 011 058. All rights reserved.

